

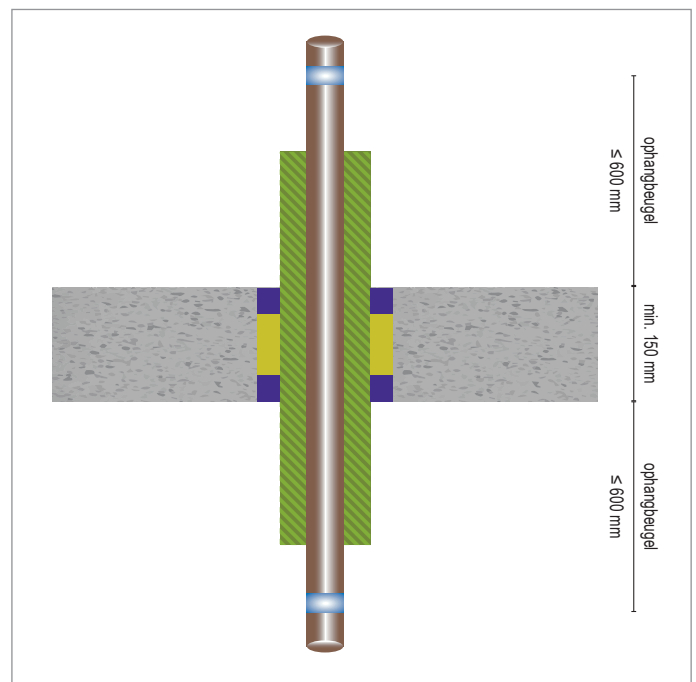

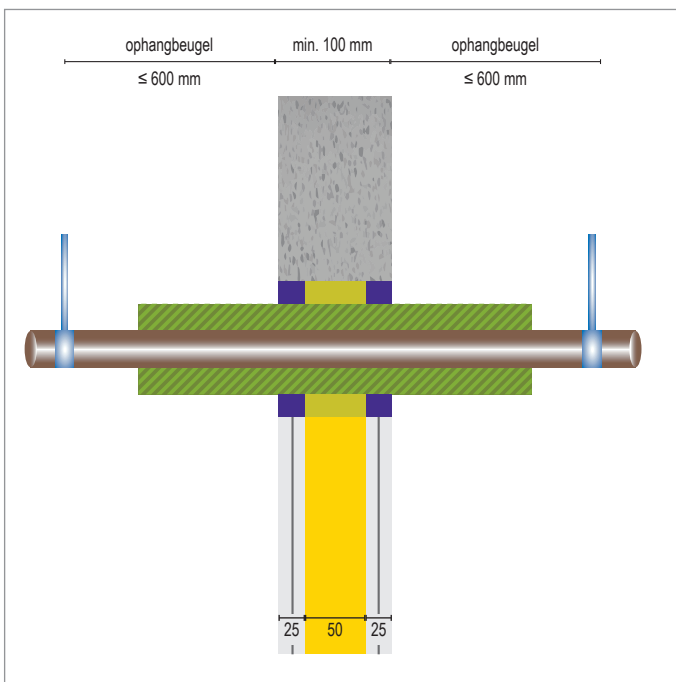





# FLAMRO® DG-SC Grafietkit

## Steenwol schaal / Brandwerende grafietkit



### KLEINE SPARING < 40 MM

-  Niet-brandbare Metalen leiding
-  Steenwol schaal
-  Lichte Scheidingswand
-  Massieve Wand / Massieve Vloer
-  FLAMRO® DG-SC Grafietkit

Doorvoer	Diameter (max)	Isolatie	Dikte	Lengte Schaal	Brandweerstandsklasse		Goedkeurings document
					Wand	Vloer	
 Koperbuis	≤ 88,9	Rw. schaal CS/CI	50	≥ 1000	EI = 120	EI = 120	ETA 19/0704
 Staalbuis	≤ 114	Rw. schaal CS/CI	50	≥ 1000	EI = 120	EI = 120	ETA 19/0704

Deze handleiding dient als ondersteuning voor een juiste montage.  
Voor uitgebreide montagedetails, zie *Installation Manual*

Alle maten in mm

Bij afwijkende situaties raadpleeg onze technische support:

 +31 10 72 71 044

 [info@svt-products.nl](mailto:info@svt-products.nl)